



東莞錦豐鈕扣廠有限公司

KAM FUNG METAL MANUFACTORY LTD



廠一區公





東莞錦豐鈕扣廠有限公司

KAM FUNG METAL MANUFACTORY LTD



锦丰钮扣厂有限公司始创于1982年在香港成立，因业务扩大发展于1995年在国内开设生产基地，属港资独资企业，座落在珠三角的东莞长安镇，厂房面积1万平方米配备最先进的钮扣生产设备及测试仪器，汇集高档服饰补料的五金钮扣生产、开发设计、销售服务于一体，多年来，公司以诚信服务，精益求精为宗旨，秉承以人为本，携手共进，开拓创新、利润共享为理念，不断提高自身的核心竞争力，以一流的模具、一流的产品，使生产的货品，畅销海内外各地，赢得广大客户的认可.....

公司自成立以来稳步发展，一直努力为各地厂方、客户提供优质服务，产品体系多元化，价格合理；信誉超著，广受海内外客户的信赖，同时更注意与新老客户的沟通与合作，以建立长期互惠互利的良好伙伴关系。



检测设备



工模部



東莞錦豐鈕扣廠有限公司

KAM FUNG METAL MANUFACTORY LTD



本公司专业以金属钮扣产品为主，一向重视产品质量及安全,多年前已获得ISO9001及Oeko-Tex Standard 100 認證，公司生产的牛仔钮、撞钉、鸡眼、唛钮、车缝钮、五爪钮、裤扣、葫芦扣、D字扣、日字扣、锌合金扣等产品，所有产品均达到欧盟、美国、日本等国家的安全和环保要求。

本公司设有钮扣产品开发部，产品设计、模具制造、生产、品检及测试、包装等工序均由本厂一条龙完成，保证产品的质量，有足够的经验和能力满足客户所需求的各类纽扣产品，我们的业务一贯以来都秉承以客为尊、热情相待的服务宗旨，随时为客户展示介绍各类产品，细心聆听及协助客户解决各种疑难,保证能在订单跟进上为客户提供详细及准确的货品资料，以尽心、尽责、尽力、的诚信精神为您服务，欢迎各地厂家来样订购、洽谈！



线扣/冲压/压铸/生产车间一角



生产车间一角

联系我们:



錦豐五金制品廠有限公司

中国香港葵涌 大連排道 182-190號
金龍工業中心 第四座17樓H-J室

电话: (852) 2426 6698

传真: (852) 2489 2127

电邮: sales@kamfung.hk

公司网页: www.kamfung.hk

www.hktdc.com/em/kamfungmetal

联系人:

劳远光 先生 总经理
雷淑儀 小姐 销售业务经理

工廠

東莞錦豐鈕扣廠有限公司

中国广东省東莞市 長安鎮 松林西路
(新安社區增田村) 邮编: 523883

电话: (86-769) 8553 9904

传真: (86-769) 8553 5902

电邮: sales.dg@kamfung.hk

联系人: 郭少勇 先生 业务主管



東莞錦豐鈕扣廠有限公司
KAM FUNG METAL MANUFACTORY LTD

工字鈕 (产品图)



GE017



GE033



GE001(C0030)



GE012(B0017)



GE008(C0031)



GE030(C0061)



GE010-B



GE034



GE015(C0033)



GE021(C0033)



東莞錦豐鈕扣廠有限公司
KAM FUNG METAL MANUFACTORY LTD

袋边钉/唛钮 (产品图)



JA015



JA027



JA008



JA001



GF002(C0007)



GG002(C0049)



GG002(C0020)



GF004(C0011)



GF006(C0046)



GF001A(C0005)



GF009(C0048)



東莞錦豐鈕扣廠有限公司
KAM FUNG METAL MANUFACTORY LTD

釘線鈕 (產品圖)



GD016



GD010



GD029



GD020



GD012



GA013



GA006B



GB008



GB021



GB019



GD026



GD024



GB027



GD007



GB002



東莞錦豐鈕扣廠有限公司
KAM FUNG METAL MANUFACTORY LTD

鸡眼/撞钉 (产品图)



HA006



HA023



HB006



HD003



HC003



HD002



JA001



JA008



JA010



JA026



HD001



HB001



JA004A



JA033



JA032



東莞錦豐鈕扣廠有限公司
KAM FUNG METAL MANUFACTORY LTD

葫芦扣/拉心扣 (产品图)



AA025(A2006)



AA021(A2002)



AA019(A2003)



AA070(A2003)



AA056(A2013)



AA005(A2009)



AA010(A2018)



AA003(A2003)



AA052



AA093



AB025



AB098



AB033



AB086



AB027



東莞錦豐鈕扣廠有限公司
KAM FUNG METAL MANUFACTORY LTD

吊帶扣/調節扣 (產品圖)



AC001



AC002B



AC002C



AC004



AC006



AD004



AD007



AD007A



AD014



AD010

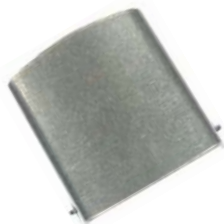

AD003



AD006.



AD011



AD008



AD012



東莞錦豐鈕扣廠有限公司
KAM FUNG METAL MANUFACTORY LTD

勾扣 (产品图)



AE004



AE009



AE017



AE007



AE011



AE028



AE029



AE032



AE024



AE027



AE005



AE013



AE022



AE008



AE015



東莞錦豐鈕扣廠有限公司
KAM FUNG METAL MANUFACTORY LTD

袋边扣/日字扣 (产品图)



DA003



DA001



DA017



DA039



DA056A



DA001A



DA098A



DA006



DA035A



DA011B



CC004



CC009



CC008



CC002



CC003



東莞錦豐鈕扣廠有限公司
KAM FUNG METAL MANUFACTORY LTD

D扣/方扣/圓圈扣 (产品图)



EA001



EA131



EA093



EA109



EA252



EA266



EB108



EB148



EB116



EB069



EB139



EB112



EC030



EC045



EC029



EC039



EC046



EC014



東莞錦豐鈕扣廠有限公司
KAM FUNG METAL MANUFACTORY LTD

绳结扣及配件 (产品图)



FC004



FC026



FA014



FA002



FA005



FA012



FA007



FA001



FC002



FC003



FD014



FD012



FD005



FD006



FD004



東莞錦豐鈕扣廠有限公司
KAM FUNG METAL MANUFACTORY LTD

双搭扣/插扣 (产品图)



DD005



DD022



DD025



DD015



DD047



DC001



DC006



DC004



DC003



DC005



DD055



DD037



DD057



DD058



DD036



東莞錦豐鈕扣廠有限公司
KAM FUNG METAL MANUFACTORY LTD

腰带针扣 (产品图)



BB094



BB017



BB104



BB026



BB106



BB025



BB070



BB096



東莞錦豐鈕扣廠有限公司
KAM FUNG METAL MANUFACTORY LTD

腰带合形扣 (产品图)



BC016A



BC021



BC003



BC013



BC007



BC015D



BC018



BC015A



東莞錦豐鈕扣廠有限公司
KAM FUNG METAL MANUFACTORY LTD

轆通針扣 (產品圖)



BD040



BD023



BD020



BD013



BD050



BD016



BD016A



BD033A



BD026



BD015A



BD006A



BD036A



BD026A



BD004A



BD001



東莞錦豐鈕扣廠有限公司
KAM FUNG METAL MANUFACTORY LTD

介子尾夾 (产品图)



BE007



BE010



BE008



BE028



BE012



BE025



BF009



BF002



BF023



BF006



BF006



BF007

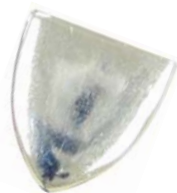

BF030



BF001

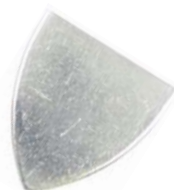

BF031



BF032



BF017



BF007A



東莞錦豐鈕扣廠有限公司
KAM FUNG METAL MANUFACTORY LTD

飾物/徽章牌 (产品图)



KJ001



KD002



KC012



KC006



KB066



KD003-ZB



KD005



KK005



KK004



KK002



KB002



KB037



KB042



KB039



KC027



東莞錦豐鈕扣廠有限公司
KAM FUNG METAL MANUFACTORY LTD

拉鏈牌 (产品图)



NB003



NB004



NB005A



NB013



NB009



NB010



NB011



NB012



NB007



NB018



NB005A.



NA003



NB022



NB021



NB020



東莞錦豐鈕扣廠有限公司
KAM FUNG METAL MANUFACTORY LTD

脚踏鈕釘鉚合機

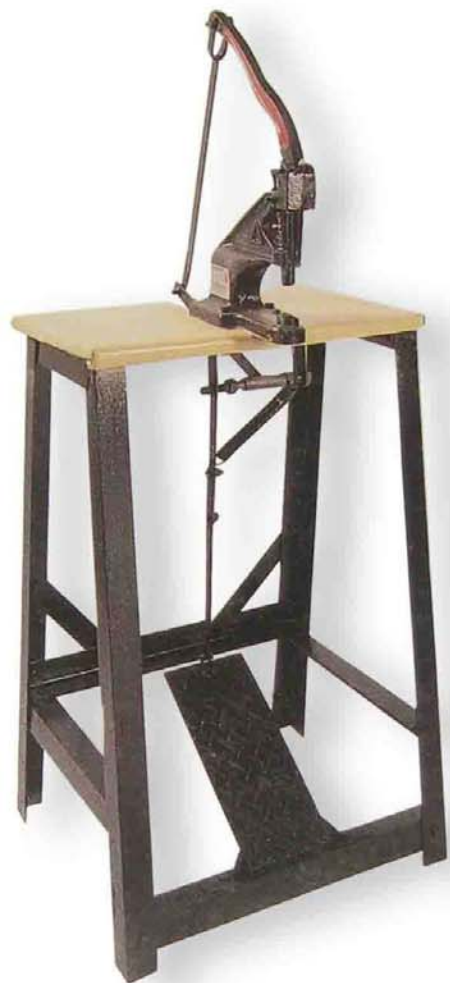

FOOT PRESSOR
脚踏鈕釘鉚合機

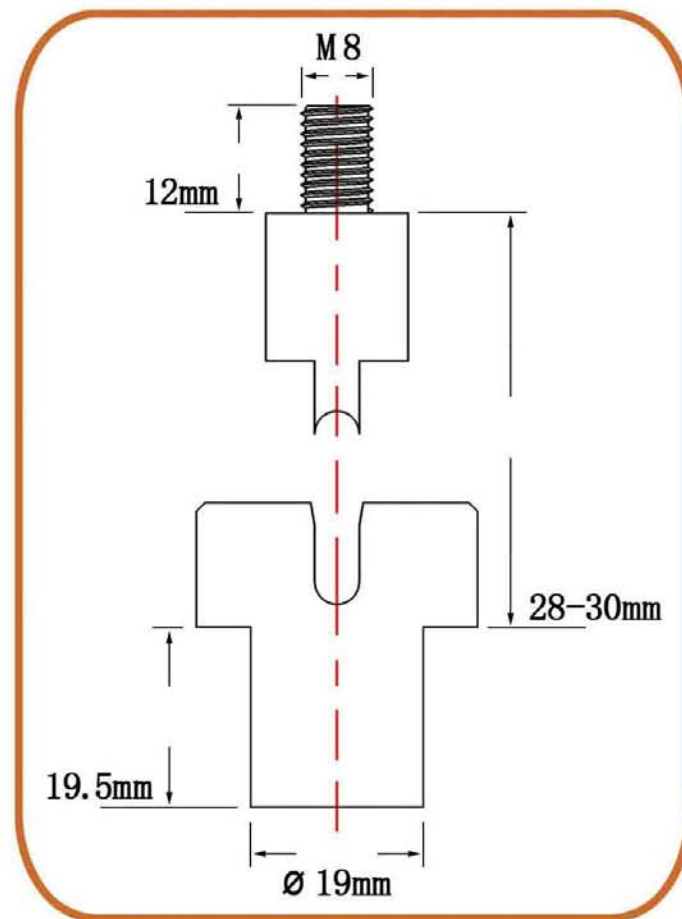

工模根據不同產品規格，可以在上模加下模
總厚度(28-30mm)範圍變動，以滿工作之需。



東莞錦豐鈕扣廠有限公司
KAM FUNG METAL MANUFACTORY LTD

电动钮钉铆合机

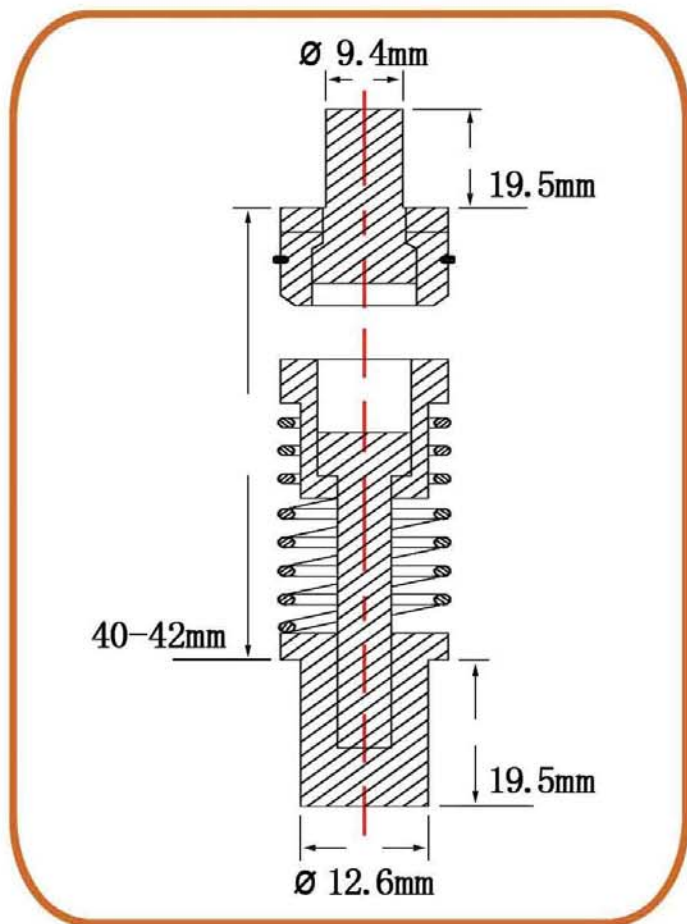

工模根據不同產品規格，可以在上模加下模
總厚度(40-42mm)範圍變動，以滿工作之需。







ELECTRIC PRESSOR
電動鈕釘铆合機

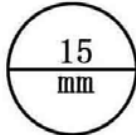
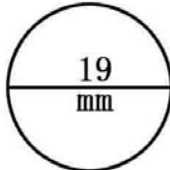
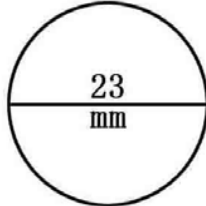

東莞錦豐鈕扣廠有限公司

KAM FUNG METAL MANUFACTORY LTD

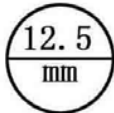
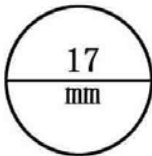
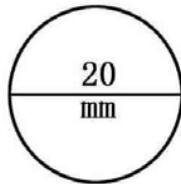
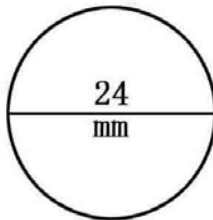
鈕号规格标准

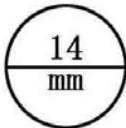
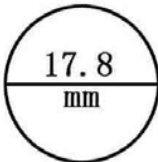
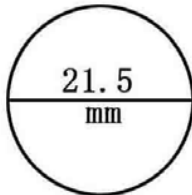
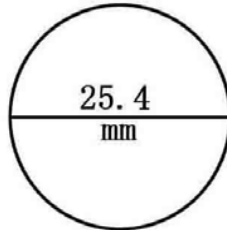
| | | | | |
|---|---|---|---|---|
| #10 | #18 | #24 | #30 | #36 |
|  |  |  |  |  |
| #14 | #20 | #26 | #32 | #38 |
|  |  |  |  |  |
| #16 | #22 | #28 | #34 | #40 |
|  |  |  |  |  |
| 1 INCH=40L=25.4MM | | 10L=6.35MM | | |



東莞錦豐鈕扣廠有限公司

KAM FUNG METAL MANUFACTORY LTD

线号规格标准

| 线号 | 线径尺寸(MM) | | 线号 | 线径尺寸(MM) | |
|-----|----------|---------|-----|----------|---------|
| | SWG标准* | BWG标准* | | SWG标准* | BWG标准* |
| 1# | Ø7.62MM | Ø7.62MM | 11# | Ø2.95MM | Ø3.05MM |
| 2# | Ø7.01MM | Ø7.21MM | 12# | Ø2.64MM | Ø2.76MM |
| 3# | Ø6.40MM | Ø6.56MM | 13# | Ø2.34MM | Ø2.41MM |
| 4# | Ø5.89MM | Ø6.05MM | 14# | Ø2.03MM | Ø2.11MM |
| 5# | Ø5.39MM | Ø5.59MM | 15# | Ø1.83MM | Ø1.83MM |
| 6# | Ø4.88MM | Ø5.16MM | 16# | Ø1.63MM | Ø1.65MM |
| 7# | Ø4.47MM | Ø4.57MM | 17# | Ø1.42MM | Ø1.47MM |
| 8# | Ø4.06MM | Ø4.19MM | 18# | Ø1.22MM | Ø1.24MM |
| 9# | Ø3.66MM | Ø3.76MM | 19# | Ø1.02MM | Ø1.07MM |
| 10# | Ø3.25MM | Ø3.40MM | 20# | Ø0.89MM | Ø0.91MM |

附注：一般市面售买的线料现货，铜线跟从SWG标准，铁线跟从BWG标准。